



**ISOLATORI di SOSPENSIONE ED AMMARRO  
CLASSE 120 kN**

**Codifica degli Isolatori**



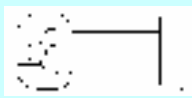
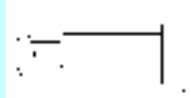
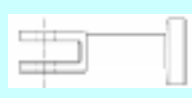

<b>I</b>	<b>S</b>	<b>N</b>	<b>S B</b>		<b>120</b>	<b>XXXX</b>
Trasmissione	Sospensione ed ormeggio	Tipo di copertura	Terminale superiore	Terminale inferiore	S.M.L. [kN]	Lunghezza di accoppiamento [mm]
		N = media polluzione  V = Altissima polluzione		S = Orbita B = Bottone C = Forcella T = Occhiolo Y = Forcella a Y E = Occhiolo ovale		

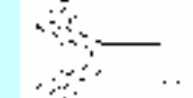
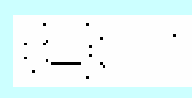
**Terminali**

I terminali standard disponibili sono in acciaio stampato e zincati a fuoco e sono conformi alle norme IEC

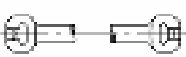
<b>S</b>	<b>B</b>	<b>C</b>	<b>T</b>	<b>Y</b>	<b>E</b>
					
Size 16A IEC 60120	Size 16A IEC 60120	Size 16L IEC 60120	Size 16L IEC 60120	Size 19 IEC 61466	Size 19 IEC 61466

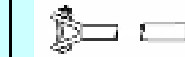
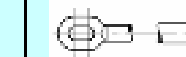
Nelle tabelle delle pagine seguenti sono indicate le caratteristiche dell'isolatore orbita-bottone TS N SB 120 XXXX.  
Per altre configurazioni di terminali tutte le caratteristiche restano invariate. Solo la lunghezza totale viene modificata come segue :

TS N SS 120 XXXX	TS N CT 120 XXXX	TS N CB 120 XXXX	TS N YB 120 XXXX	TS N EB 120 XXXX	TS N CC 120 XXXX
					
L = + 0 mm	L = + 20 mm	L = + 10 mm	L = + 20 mm	L = + 40 mm	L = + 20 mm

**Protezioni**

Per i livelli di tensione più elevati è necessario l'uso di anelli per la riduzione del campo elettrico lungo l'isolatore ed in particolare in prossimità dei terminali.

Questo tipo di anelli non sostituisce le protezioni contro le correnti di corto circuito.

Si consiglia l'impiego di un anello lato linea per  $U_m \geq 245$  kV e di due anelli per  $U_m \geq 420$  kV

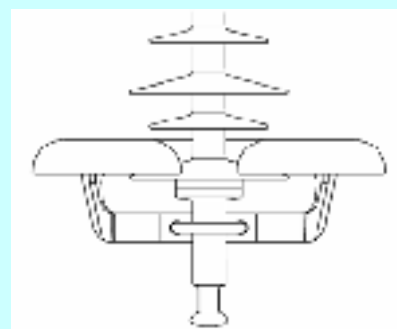

H00142

**SML 120 kN**  
**Bassa e Media polluzione**  
**TS N SB 120 XXXX**



Definizioni, metodi di prova e criteri di accettazione secondo IEC 61109/92

Tensione Massima $U_m$	Codice	Numero di alette	Lunghezza di accoppiamento	Distanza d'arco	Linea di fuga	Tenuta a impulso atmosferico	Tenuta a f.i. sotto pioggia	Peso
[kV]			[mm]	[mm]	[mm]	[kV]	[kV]	[kg]

123 / 170	TS N SB 120 1010	21	1010	840	2565	490	265	4.4
	TS N SB 120 1085	23	1085	915	2810	535	290	4.7
	TS N SB 120 1160	25	1160	990	3060	580	310	4.9
	TS N SB 120 1235	27	1235	1065	3305	620	335	5.1
	TS N SB 120 1310	29	1310	1140	3550	665	355	5.4
	TS N SB 120 1385	31	1385	1215	3795	705	380	5.6
	TS N SB 120 1460	33	1460	1290	4045	745	400	5.9
	TS N SB 120 1535	35	1535	1365	4290	785	420	6.1
	TS N SB 120 1610	37	1610	1440	4535	825	440	6.4

245 / 300 con 1 anello	TS N SB 120 1985	47	1985	1715	5765	970	510	8.8
	TS N SB 120 2135	51	2135	1865	6260	1050	550	9.3
	TS N SB 120 2285	55	2285	2015	6750	1130	585	9.8
	TS N SB 120 2435	59	2435	2165	7425	1215	620	10.3
	TS N SB 120 2585	63	2585	2315	7735	1295	650	10.8
	TS N SB 120 2735	67	2735	2465	8230	1375	685	11.3
	TS N SB 120 2885	71	2885	2615	8720	1460	715	11.8

≥ 420 con 2 anelli	TS N SB 120 3035	75	3035	2715	9215	1515	730	13.6
	TS N SB 120 3185	79	3185	2865	9705	1595	760	14.1
	TS N SB 120 3335	83	3335	3015	10200	1675	785	14.6
	TS N SB 120 3485	87	3485	3165	10690	1760	810	15.1
	TS N SB 120 3635	91	3635	3315	11180	1850	830	15.6
	TS N SB 120 3785	95	3785	3465	11675	1920	850	16.1
	TS N SB 120 3935	99	3935	3615	12165	1990	870	16.6
	TS N SB 120 4085	103	4085	3765	12660	2060	890	17.1
	TS N SB 120 4235	107	4235	3915	13150	2140	905	17.6
	TS N SB 120 4385	111	4385	4065	13645	2220	920	18.1
	TS N SB 120 4535	115	4535	4215	14135	2300	935	18.6
	TS N SB 120 4685	119	4685	4365	14630	2380	950	19.1
	TS N SB 120 4835	123	4835	4515	15120	2460	960	19.6
	TS N SB 120 4985	127	4985	4665	15615	2540	970	20.1
	TS N SB 120 5135	131	5135	4815	16105	2620	980	20.6

**SML 120 kN**  
**Alta ed Altissima polluzione**  
**TS V SB 120 XXXX**



Definizioni, metodi di prova e criteri di accettazione secondo IEC 61109/92

Tensione Massima U <sub>m</sub>	Codice	Numero di alette	Lunghezza di accoppiamento	Distanza d'arco	Linea di fuga	Tenuta a impulso atmosferico	Tenuta a f.i. sotto pioggia	Peso
[kV]			[mm]	[mm]	[mm]	[kV]	[kV]	[kg]

123 / 170	TS V SB 120 0990	25	990	835	3270	475	230	5.8
	TS V SB 120 1050	27	1050	895	3530	510	245	6.1
	TS V SB 120 1110	29	1110	955	3795	545	265	6.4
	TS V SB 120 1170	31	1170	1015	4055	580	280	6.7
	TS V SB 120 1230	33	1230	1075	4315	615	295	7.0
	TS V SB 120 1295	35	1295	1135	4585	645	310	7.4
	TS V SB 120 1355	37	1355	1195	4845	680	325	7.7
	TS V SB 120 1415	39	1415	1255	5150	715	340	8.0
	TS V SB 120 1475	41	1475	1315	5370	745	355	8.3
TS V SB 120 1535	43	1535	1375	5630	780	370	8.6	
TS V SB 120 1595	45	1595	1440	5890	815	385	9.0	

245 / 300 con 1 anello	TS V SB 120 1960	57	1960	1710	7465	965	440	12.1
	TS V SB 120 2020	59	2020	1770	7730	995	450	12.4
	TS V SB 120 2080	61	2080	1830	7990	1030	465	12.7
	TS V SB 120 2140	63	2140	1890	8250	1065	475	13.0
	TS V SB 120 2260	67	2260	2010	8775	1130	500	13.6
	TS V SB 120 2380	71	2380	2130	9300	1195	525	14.3
	TS V SB 120 2505	75	2505	2255	9825	1265	545	14.9
	TS V SB 120 2625	79	2625	2375	10350	1330	570	15.5
TS V SB 120 2745	83	2745	2495	10875	1395	590	16.2	

≥ 420 con 2 anelli	TS V SB 120 2925	89	2925	2605	11660	1455	605	18.4
	TS V SB 120 3045	93	3045	2725	12180	1520	625	19.1
	TS V SB 120 3170	97	3170	2850	12710	1590	640	19.7
	TS V SB 120 3290	101	3290	2970	13235	1655	655	20.3
	TS V SB 120 3410	105	3410	3090	13755	1720	670	21.0
	TS V SB 120 3530	109	3530	3210	14280	1785	685	21.6
	TS V SB 120 3650	113	3650	3330	14805	1845	700	22.2
	TS V SB 120 3775	117	3775	3455	15330	1915	710	22.9
	TS V SB 120 3895	121	3895	3575	15855	1980	725	23.5
	TS V SB 120 4015	125	4015	3695	16380	2040	735	24.1
	TS V SB 120 4135	129	4135	3815	16900	2105	745	24.8
	TS V SB 120 4255	133	4255	3935	17425	2165	755	25.4
	TS V SB 120 4380	137	4380	4060	17955	2235	765	26.0
	TS V SB 120 4500	141	4500	4180	18475	2295	775	26.7
	TS V SB 120 4620	145	4620	4300	19000	2360	785	27.3
	TS V SB 120 4740	149	4740	4420	19525	2420	795	27.9
TS V SB 120 4860	153	4860	4540	20045	2485	805	28.6	
TS V SB 120 4985	157	4985	4665	20575	2550	815	29.2	