







## ISOLATORI di SOSPENSIONE ED AMMARRO CLASSE 160 kN

### Codifica degli Isolatori





<b>I</b>	<b>S</b>	<b>N</b>	<b>S B</b>		<b>160</b>	<b>XXXX</b>
Trasmissione	Sospensione ed ormeggio	Tipo di copertura	Terminale superiore	Terminale inferiore	S.M.L. [kN]	Lunghezza di accoppiamento [mm]
Um > 100 kV		N = media polluzione  V = Altissima polluzione		S = Orbita B = Bottone C = Forcella T = Occhiolo Y = Forcella a Y E = Occhiolo ovale		

### Terminali

I terminali standard disponibili sono in acciaio stampato e zincati a fuoco e sono conformi alle norme IEC

<b>S</b>	<b>B</b>	<b>C</b>	<b>T</b>	<b>Y</b>	<b>E</b>
					
Size 20 IEC 60120	Size 20 IEC 60120	Size 19L IEC 60120	Size 19L IEC 60120	Size 22 IEC 61466	Size 25 IEC 61466

Nelle tabelle delle pagine seguenti sono indicate le caratteristiche dell'isolatore orbita-bottone TS N SB 120 XXXX. Per altre configurazioni di terminali tutte le caratteristiche restano invariate. Solo la lunghezza totale viene modificata come segue :

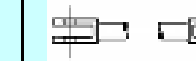
TS N SS 160 XXXX	TS N CT 160 XXXX	TS N CB 160 XXXX	TS N YB 160 XXXX	TS N EB 160 XXXX	TS N CC 160 XXXX
					
L = + 15 mm	L = + 10 mm	L = + 0 mm	L = +10 mm	L = + 5 mm	L = + 0 mm

### Protezioni

Per i livelli di tensione più elevati è necessario l'uso di anelli per la riduzione del campo elettrico lungo l'isolatore ed in particolare in prossimità dei terminali.

Questo tipo di anelli non sostituisce le protezioni contro le correnti di corto circuito.

Si consiglia l'impiego di un anello lato linea per Um ≥ 245 kV e di due anelli per Um ≥ 420 kV

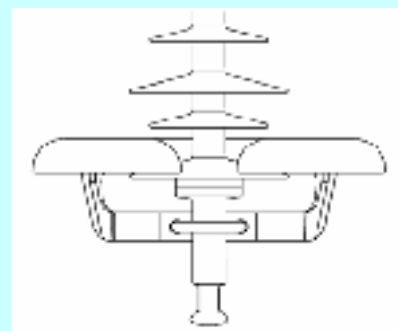

H00142

**SML 160 kN**  
**Bassa e Media polluzione**  
**TS N SB 160 XXX**

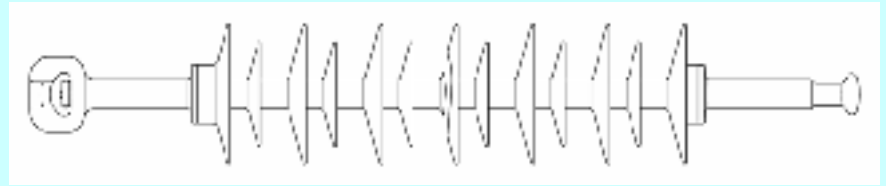

Definizioni, metodi di prova e criteri di accettazione secondo IEC 61109/92

Tensione Massima $U_m$	Codice	Numero di alette	Lunghezza di accoppiamento	Distanza d'arco	Linea di fuga	Tenuta a impulso atmosferico	Tenuta a f.i. sotto pioggia	Peso
[kV]			[mm]	[mm]	[mm]	[kV]	[kV]	[kg]

123 / 170	TS N SB 160 1095	21	1095	840	2565	490	265	5.3
	TS N SB 160 1170	23	1170	915	2810	535	290	5.5
	TS N SB 160 1245	25	1245	990	3060	580	310	5.8
	TS N SB 160 1320	27	1320	1065	3305	620	335	6.0
	TS N SB 160 1395	29	1395	1140	3550	665	355	6.3
	TS N SB 160 1470	31	1470	1215	3795	705	380	6.5
	TS N SB 160 1545	33	1545	1290	4045	745	400	6.8
	TS N SB 160 1620	35	1620	1365	4290	785	420	7.0
	TS N SB 160 1695	37	1695	1440	4535	825	440	7.3

245 / 300 con 1 anello	TS N SB 160 2070	47	2070	1715	5765	970	510	9.7
	TS N SB 160 2220	51	2220	1865	6260	1050	550	10.2
	TS N SB 160 2370	55	2370	2015	6750	1130	585	10.7
	TS N SB 160 2520	59	2520	2165	7425	1215	620	11.2
	TS N SB 160 2670	63	2670	2315	7735	1295	650	11.7
	TS N SB 160 2820	67	2820	2465	8230	1375	685	12.2
	TS N SB 160 2970	71	2970	2615	8720	1460	715	12.7

≥ 420 con 2 anelli	TS N SB 160 3120	75	3120	2715	9215	1515	730	14.5
	TS N SB 160 3270	79	3270	2865	9705	1595	760	15.0
	TS N SB 160 3420	83	3420	3015	10200	1675	785	15.5
	TS N SB 160 3570	87	3570	3165	10690	1760	810	16.0
	TS N SB 160 3720	91	3720	3315	11180	1850	830	16.5
	TS N SB 160 3870	95	3870	3465	11675	1920	850	17.0
	TS N SB 160 4020	99	4020	3615	12165	1990	870	17.5
	TS N SB 160 4170	103	4170	3765	12660	2060	890	18.0
	TS N SB 160 4320	107	4320	3915	13150	2140	905	18.5
	TS N SB 160 4470	111	4470	4065	13645	2220	920	19.0
	TS N SB 160 4620	115	4620	4215	14135	2300	935	19.5
	TS N SB 160 4770	119	4770	4365	14630	2380	950	20.0
	TS N SB 160 4920	123	4920	4515	15120	2460	960	20.5
	TS N SB 160 5070	127	5070	4665	15615	2540	970	21.0
TS N SB 160 5220	131	5220	4815	16105	2620	980	21.5	

**SML 160 kN**  
**Alta ed Altissima polluzione**  
**TS V SB 160 XXX**

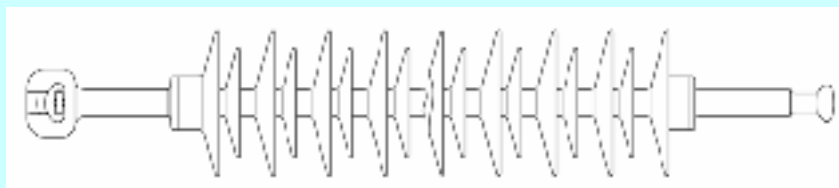

Definizioni, metodi di prova e criteri di accettazione secondo IEC 61109/92

Tensione Massima U <sub>m</sub>	Codice	Numero di alette	Lunghezza di accoppiamento	Distanza d'arco	Linea di fuga	Tenuta a impulso atmosferico	Tenuta a f.i. sotto pioggia	Peso
[kV]			[mm]	[mm]	[mm]	[kV]	[kV]	[kg]

123 / 170	TS V SB 160 1075	25	1075	835	3270	475	230	6.6
	TS V SB 160 1135	27	1135	895	3530	510	245	7.0
	TS V SB 160 1195	29	1195	955	3795	545	265	7.3
	TS V SB 160 1255	31	1255	1015	4055	580	280	7.6
	TS V SB 160 1315	33	1315	1075	4315	615	295	7.9
	TS V SB 160 1380	35	1380	1135	4585	645	310	8.2
	TS V SB 160 1440	37	1440	1195	4845	680	325	8.6
	TS V SB 160 1500	39	1500	1255	5150	715	340	8.9
	TS V SB 160 1560	41	1560	1315	5370	745	355	9.2
	TS V SB 160 1620	43	1620	1375	5630	780	370	9.5
TS V SB 160 1680	45	1680	1440	5890	815	385	9.8	

245 / 300 con 1 anello	TS V SB 160 2045	57	2045	1710	7465	965	440	12.9
	TS V SB 160 2105	59	2105	1770	7730	995	450	13.2
	TS V SB 160 2165	61	2165	1830	7990	1030	465	13.4
	TS V SB 160 2225	63	2225	1890	8250	1065	475	13.7
	TS V SB 160 2345	67	2345	2010	8775	1130	500	14.5
	TS V SB 160 2465	71	2465	2130	9300	1195	525	15.1
	TS V SB 160 2590	75	2590	2255	9825	1265	545	15.8
	TS V SB 160 2710	79	2710	2375	10350	1330	570	16.4
	TS V SB 160 2830	83	2830	2495	10875	1395	590	17.0

≥ 420 con 2 anelli	TS V SB 160 3010	89	3010	2605	11660	1455	605	19.3
	TS V SB 160 3130	93	3130	2725	12180	1520	625	19.9
	TS V SB 160 3255	97	3255	2850	12710	1590	640	20.6
	TS V SB 160 3375	101	3375	2970	13235	1655	655	21.2
	TS V SB 160 3495	105	3495	3090	13755	1720	670	21.8
	TS V SB 160 3615	109	3615	3210	14280	1785	685	22.5
	TS V SB 160 3735	113	3735	3330	14805	1845	700	23.1
	TS V SB 160 3860	117	3860	3455	15330	1915	710	23.7
	TS V SB 160 3980	121	3980	3575	15855	1980	725	24.4
	TS V SB 160 4100	125	4100	3695	16380	2040	735	25.0
	TS V SB 160 4220	129	4220	3815	16900	2105	745	25.6
	TS V SB 160 4340	133	4340	3935	17425	2165	755	26.3
	TS V SB 160 4465	137	4465	4060	17955	2235	765	26.9
	TS V SB 160 4585	141	4585	4180	18475	2295	775	27.5
	TS V SB 160 4705	145	4705	4300	19000	2360	785	28.2
	TS V SB 160 4825	149	4825	4420	19525	2420	795	28.8
	TS V SB 160 4945	153	4945	4540	20045	2485	805	29.4
	TS V SB 160 5070	157	5070	4665	20575	2550	815	30.1